

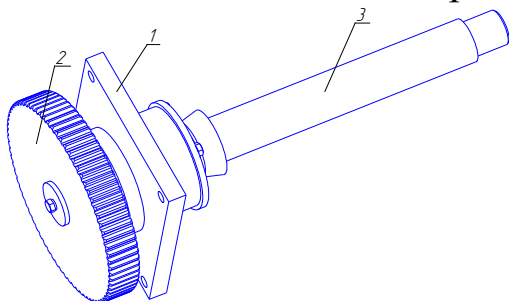

Комплект для изготовления масла

ОВОР-450

КПМ-400.03.000 Блок жаровен

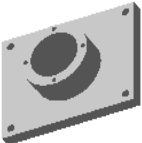
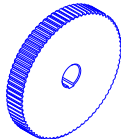
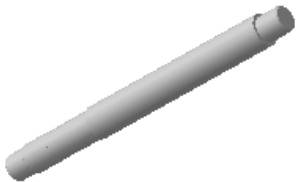
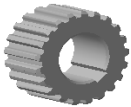

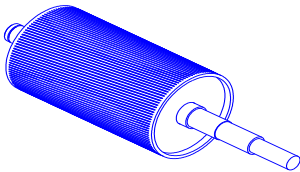
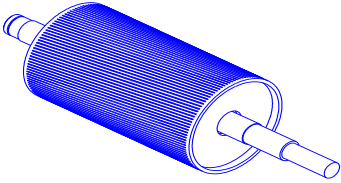
<p>Поз.1</p>  <p>КПМ-400.03.200 Корпус m = 7 кг.</p>	<p>Поз.2</p>  <p>КПМ-400.03.191 Колесо зубчатое Ø=234мм Z=76</p>	<p>Поз.3</p>  <p>КПМ-400.03.195 Вал m =8 кг.Ст45.</p>
 <p>КПМ-400.03.181 Шестерня.m =0,59кг Øвнут.=35мм Z=21</p>	 <p>КПМ-400.03.182 Втулка.m =0,2кг.</p>	 <p>ПМ-400.03.013 Звездочка Z=12</p>
 <p>КПМ-400.35.100 Валок m = 37 кг.</p>		 <p>КПМ-400.35.200 Валок m = 37,8 кг.</p>