

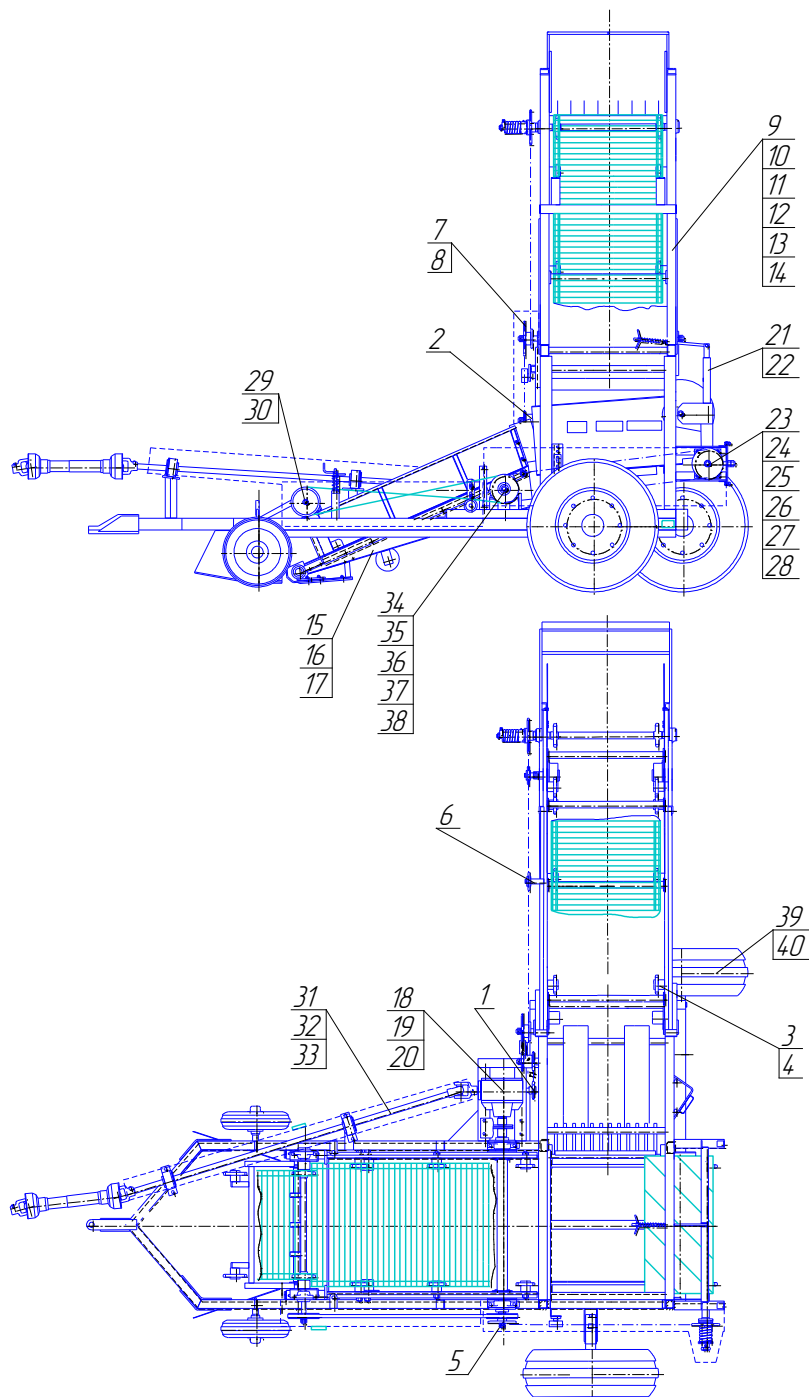









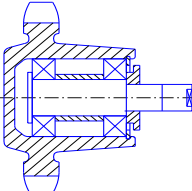

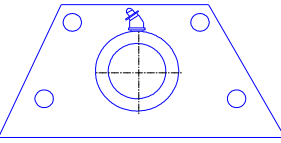



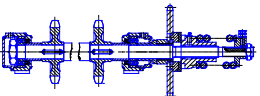
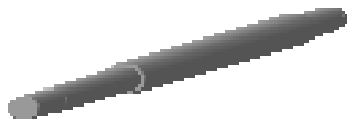
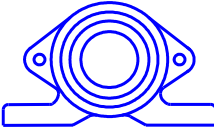
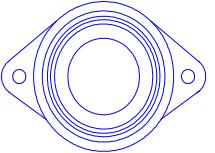
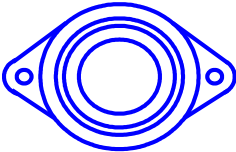

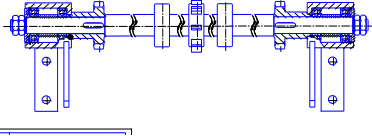

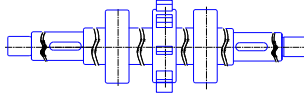
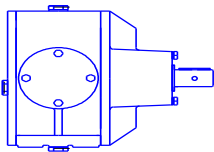
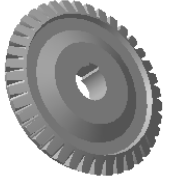
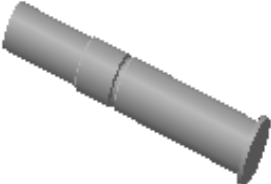

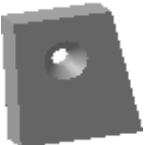
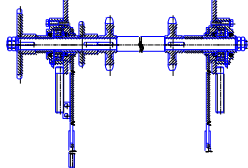
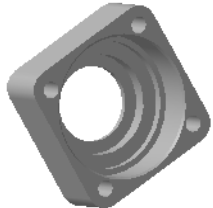



# Подборщик-погрузчик свеклы АЗК-6.03

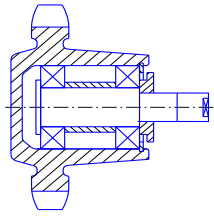

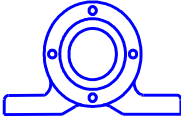
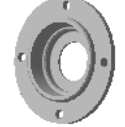
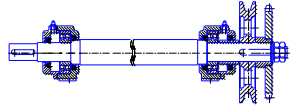
<b>ПНБ-6.08.300</b> Полотно прижимного транспортера	<b>ПНБ-6.09.000</b> Полотно загрузочного транспортера	<b>ПНБ-6.13.000</b> Полотно выгрузного транспортера
Поз.1  <b>ПНБ-6.00.005</b> Звездочка	Поз.2  <b>ПНБ-6.00.007</b> Звездочка	Поз.3  <b>ПНБ-6.00.040</b> Звездочка
Поз.4  <b>ПНБ-6.00.041</b> Звездочка	Поз.5  <b>ПНБ-6.00.060</b> Переходник	Поз.6  <b>ПНБ-6.00.200</b> Звездочка в сборе
Поз.7  <b>ПНБ-6.00.202</b> Звездочка	Поз.8  <b>МГ-6.01.912</b> Звездочка	Поз.9  <b>ПНБ-6.02.100</b> Вал приводной
Поз.10  <b>ПНБ-6.02.101</b> Вал привода	Поз.11  <b>ПНБ-6.02.103</b> Корпус	Поз.12  <b>ПНБ-6.02.104</b> Корпус

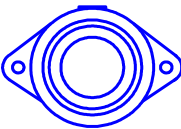
<p>Поз.13</p>  <p><b>ПНБ-6.02.105</b> Корпус</p>	<p>Поз.14</p>  <p><b>ПНБ-6.02.140</b> Звездочка</p>	<p>Поз.15</p>  <p><b>ПНБ-6.03.200</b> Вал промежуточный</p>
<p>Поз.16</p>  <p><b>ПНБ-6.03.201</b> Звездочка</p>	<p>Поз.17</p>  <p><b>ПНБ-6.03.210</b> Вал</p>	<p>Поз.18</p>  <p><b>ПНБ-6.04.000</b> Редуктор</p>
<p>Поз.19</p>  <p><b>ПНБ-6.04.006</b> Колесо коническое</p>	<p>Поз.20</p>  <p><b>ПНБ-6.04.009</b> Вал</p>	<p>Поз.21</p>  <p><b>ПНБ-6.05.008</b> Звездочка</p>
<p>Поз.22</p>  <p><b>ПНБ-6.05.010</b> Отбойник</p>	<p>Поз.23</p>  <p><b>Б-6.07.000</b> Вал приводной</p>	<p>Поз.24</p>  <p><b>ПНБ-6.07.002</b> Корпус подшипника</p>

<p>Поз.25</p>  <p><b>ПНБ-6.07.004</b> Вал</p>	<p>Поз.26</p>  <p><b>ПНБ-6.07.200</b> Звездочка</p>	<p>Поз.27</p>  <p><b>ПНБ-6.07.250</b> Звездочка</p>
<p>Поз.28</p>  <p><b>ПНБ-6.07.300</b> Звездочка</p>	<p>Поз.29</p>  <p><b>ПНБ-6.08.200</b> Вал приводной</p>	<p>Поз.30</p>  <p><b>ПНБ-6.08.400</b> Звездочка</p>
<p>Поз.31</p>  <p><b>ПНБ-6.10.001</b> Вал</p>	<p>Поз.32</p>  <p><b>ПНБ-6.10.002</b> Корпус подшипника</p>	<p>Поз.33</p>  <p><b>ПНБ-6.10.003</b> Крышка</p>
<p>Поз.34</p>  <p><b>ПНБ-6.14.000</b> Вал промежуточный</p>	<p>Поз.35</p>  <p><b>ПНБ-6.14.001</b> Вал</p>	<p>Поз.36</p>  <p><b>ПНБ-6.14.003</b> Корпус</p>
<p>Поз.37</p>  <p><b>ПНБ-6.14.004</b> Корпус</p>	<p>Поз.38</p>  <p><b>ПНБ-6.14.020</b> Звездочка</p>	<p>Поз.39,40</p>  <p><b>ПНБ-6.17.001</b> Ось L=660 <b>ПНБ-6.17.001-01</b> Ось L=620</p>